

VESELA



SLOVARICA

PRIREDILA ZA ZLATNU DJECU:

NATALI ŠARIĆ

Čepin – Split, 2012. god.

A a



Aa



auto

A

a

Aa

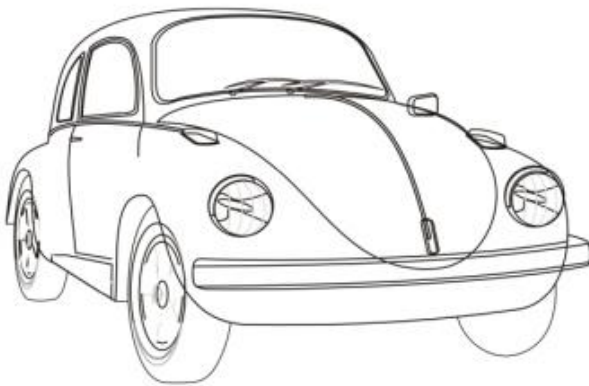

Aa

B b



Bb



bor

B

b

Bb



Bb

C C



Cc



cvijet

C

c

Cc



Cc

Č

č

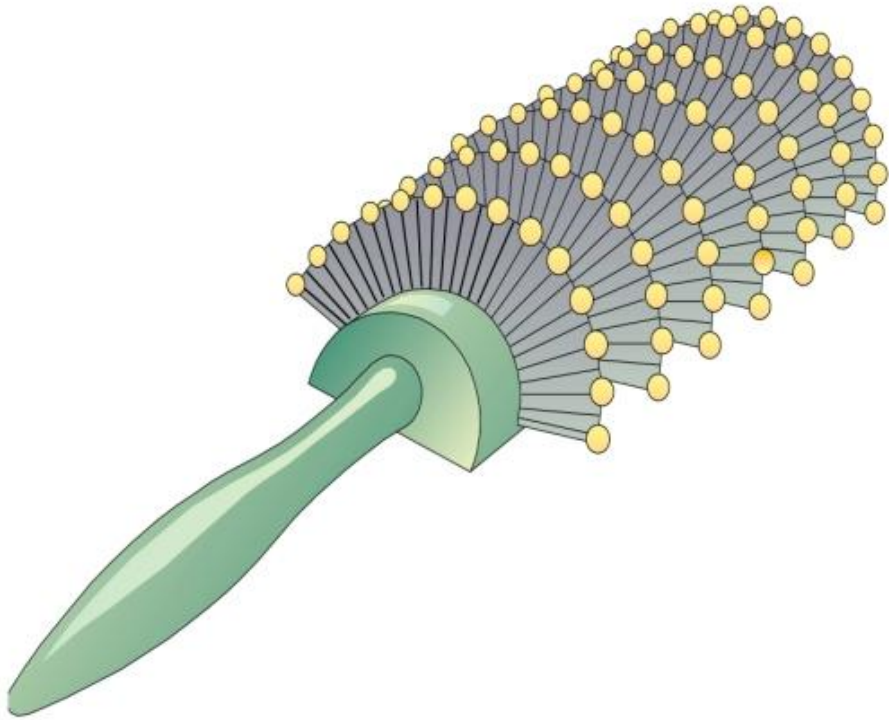

Čč

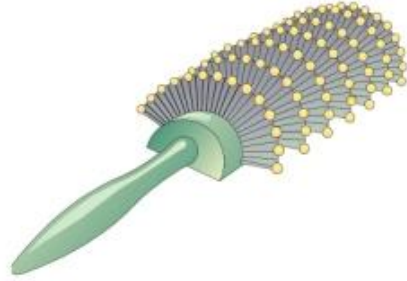

četka

Č

č

Čč

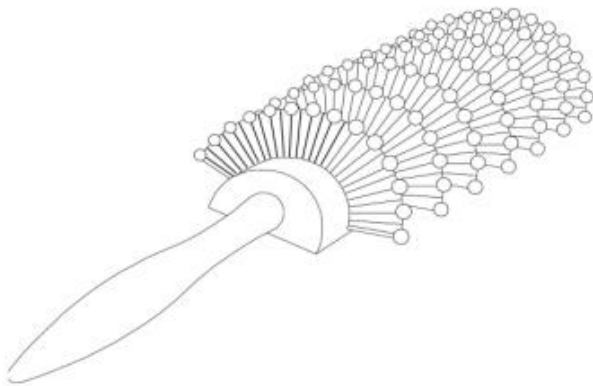

Č č

Ć ć

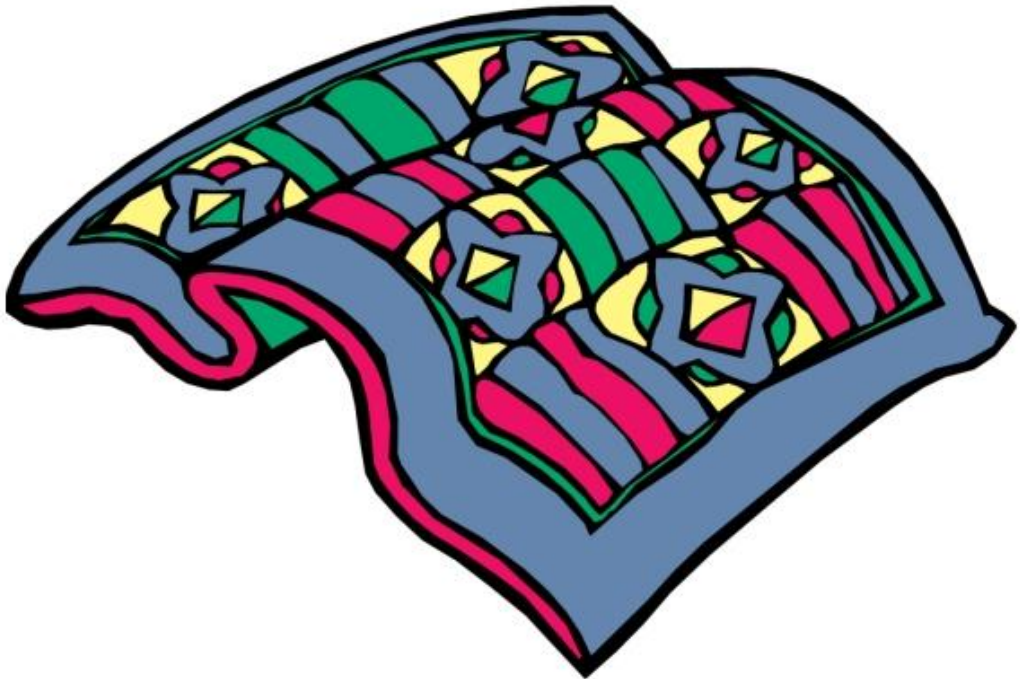

Ćć



ćilim

Ć

ć

Ćć

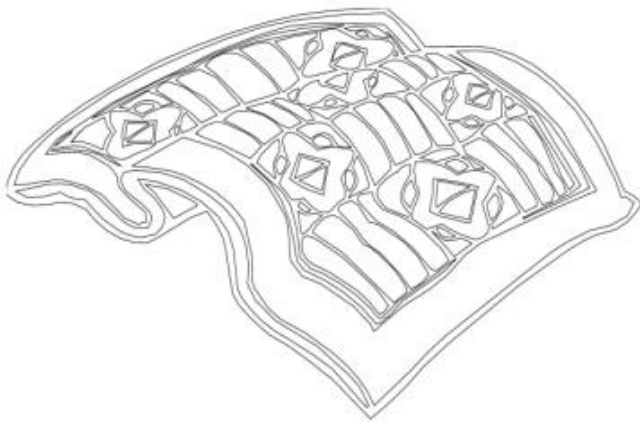

Ćć

D d



Dd



dijete

D

d

Dd



Dd

Dž dž



Dždž



džemper

Dž

dž

Dždž



Dždž

D d

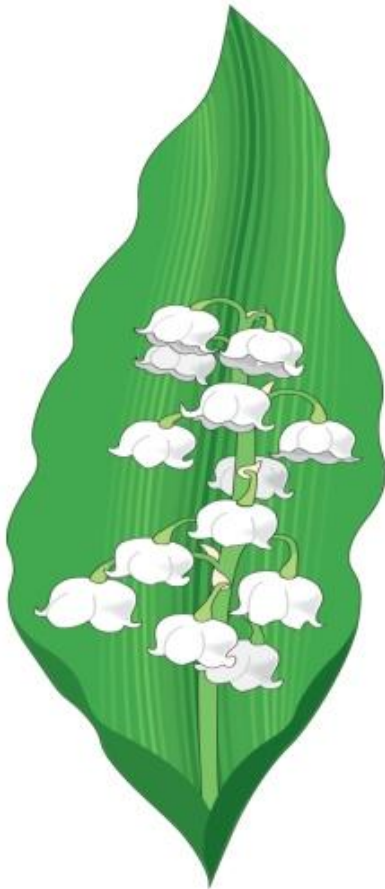

Đ đ



đurđica

Đ

đ

Đ đ

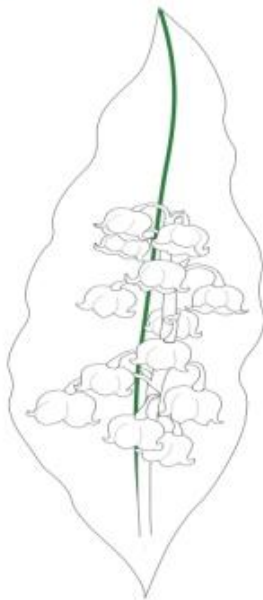

Đ đ

E e



Ee



Eskim

E

e

Ee



Ee

F f

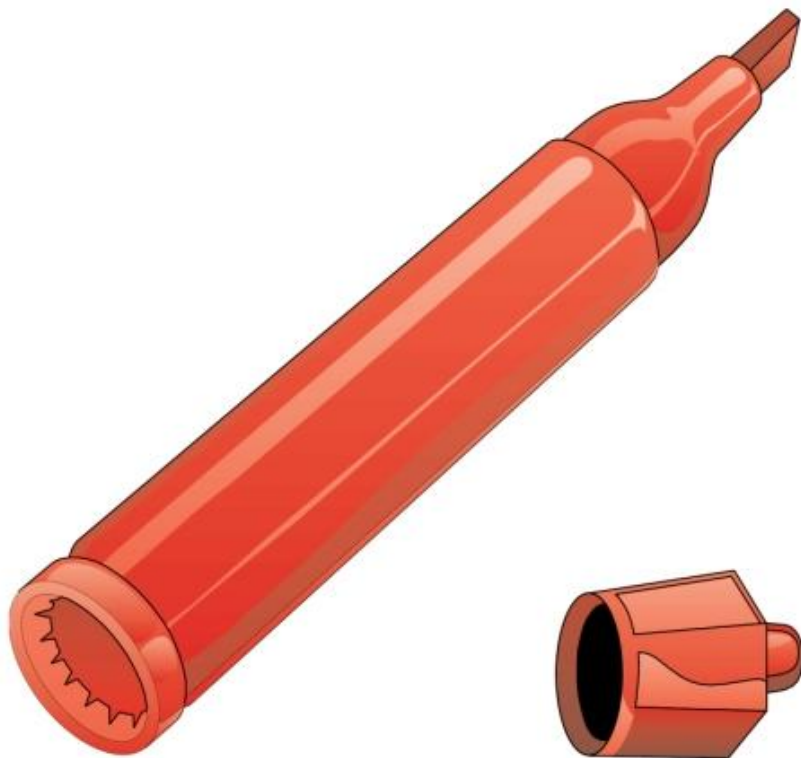

Ff



flomaster

F

f

Ff

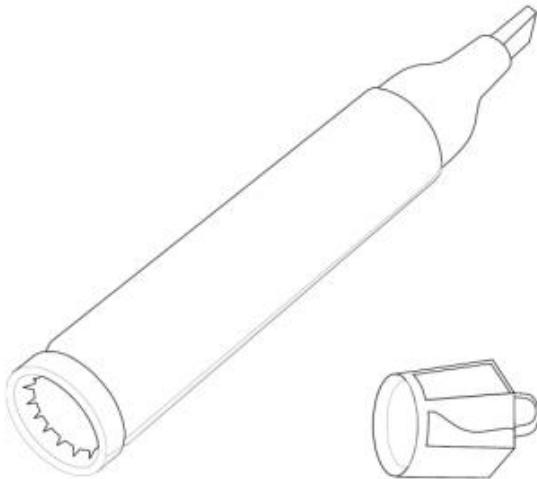

Ff

G g



Gg



gitara

G

g

Gg



Gg

H h



Hh



harmonika

H

h

Hh

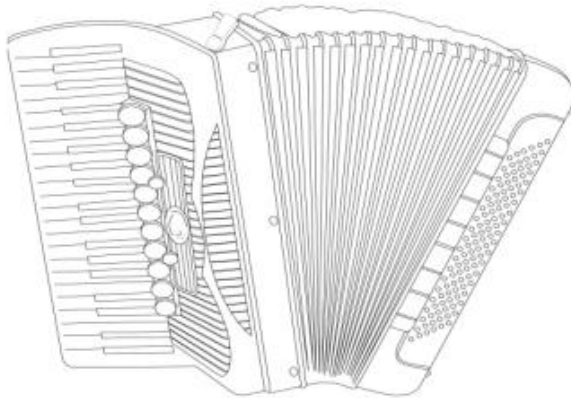

Hh

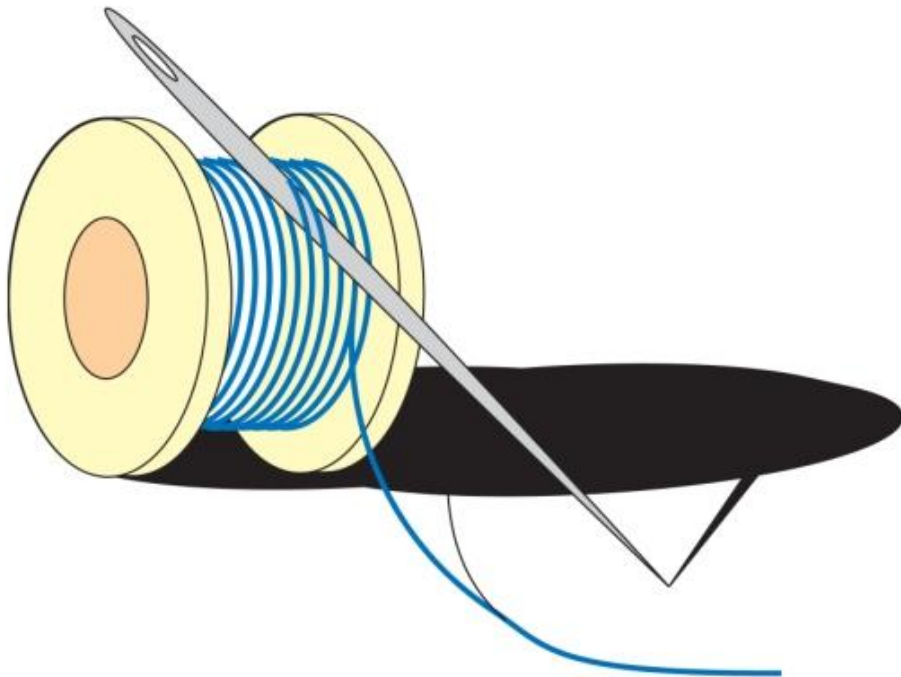

l i

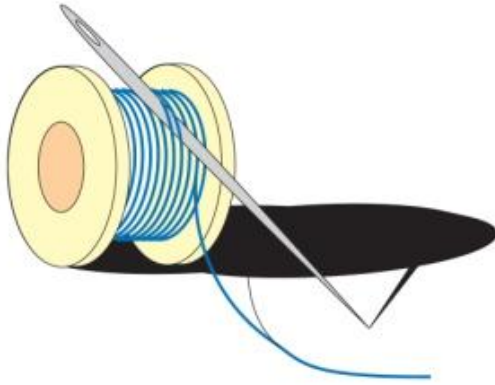

igla

l

i

li

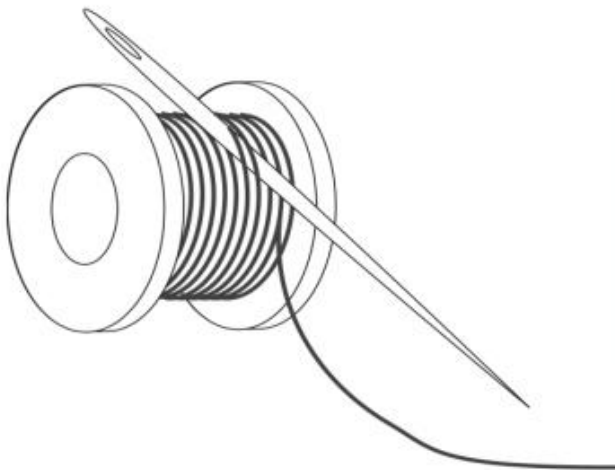

J j



Jz



jakna

J

j

Jz



Jz

K K

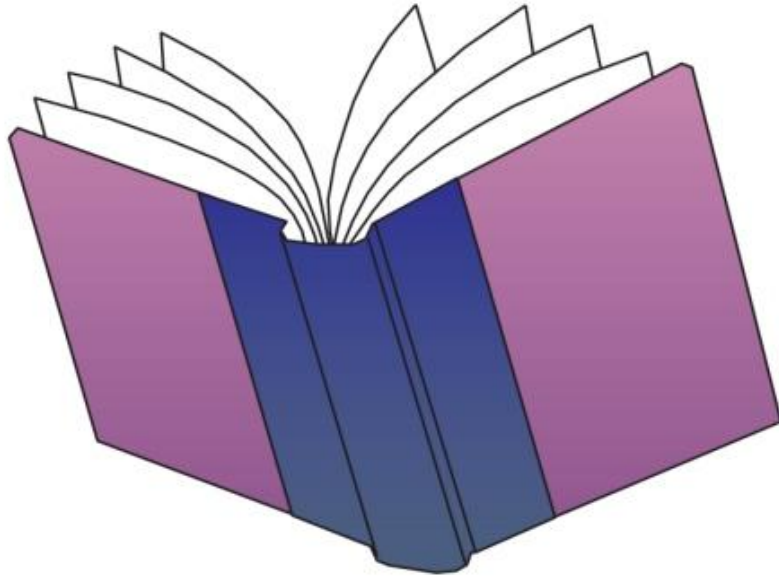

Kk



knjiga

K

k

Kk

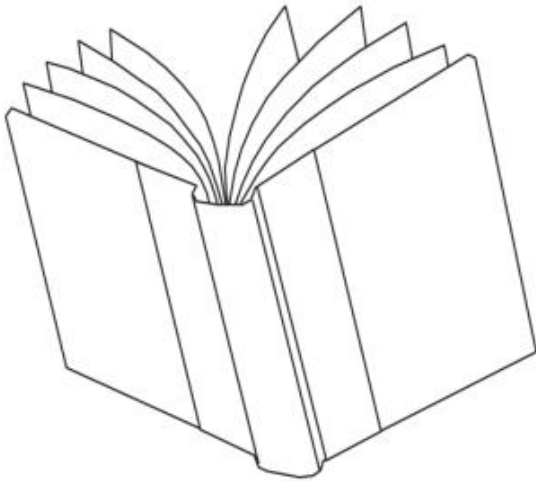

Kk

L I

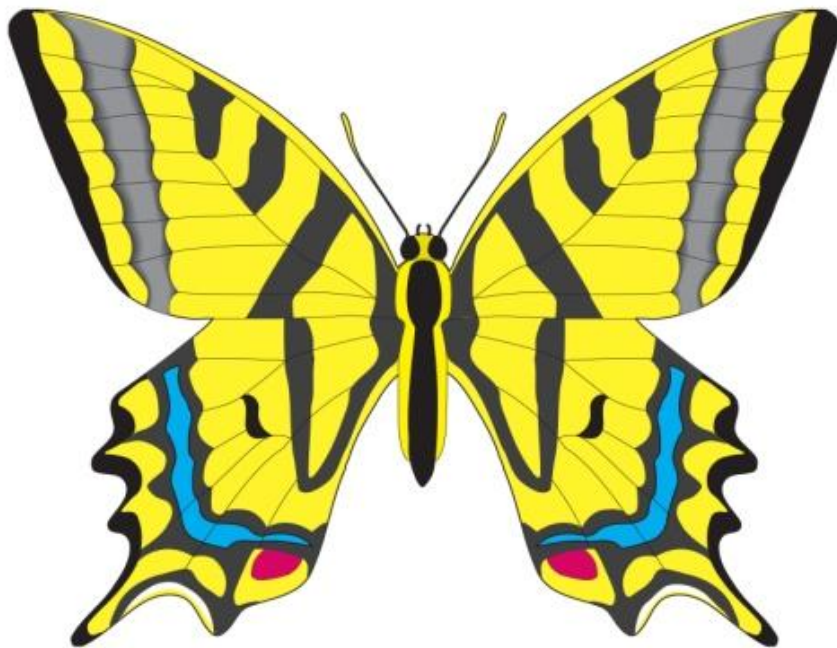

L I



leptir

L

I

L I

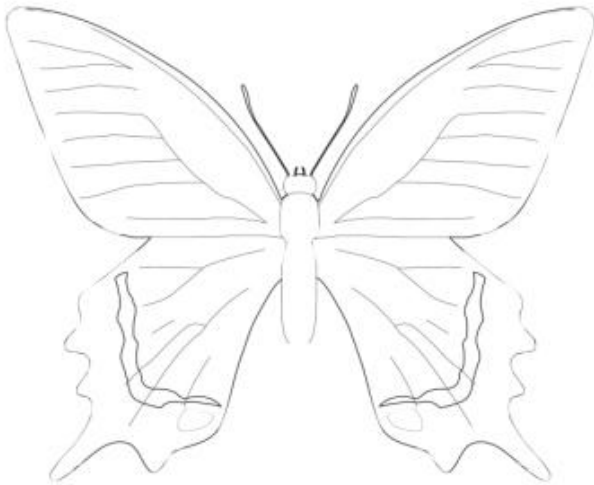

L I

Ljilji



Lj lj



ljuljačka

LJ

lj

Lj lj



Lj lj

Mm



Mm



med

M

m

Mm



Mm

N n

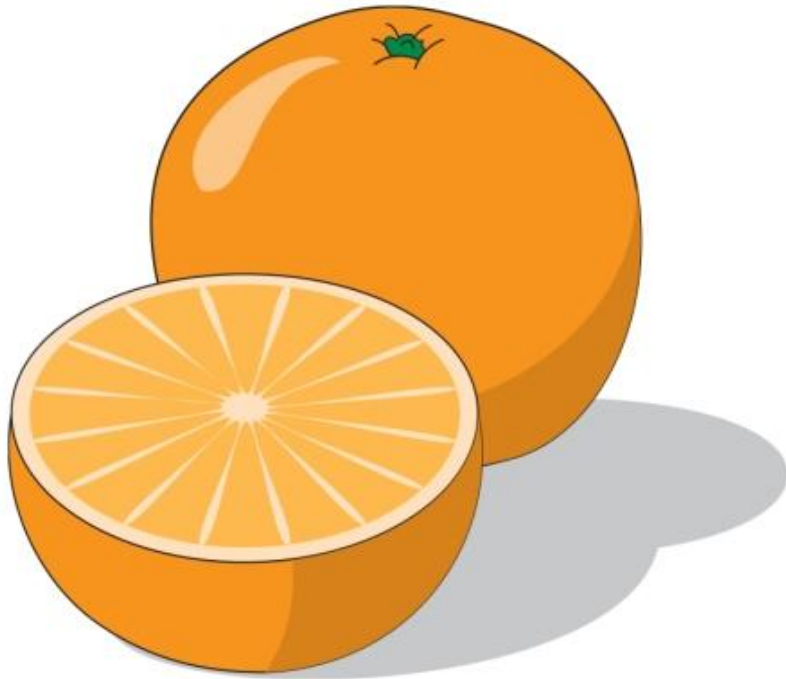

Nn

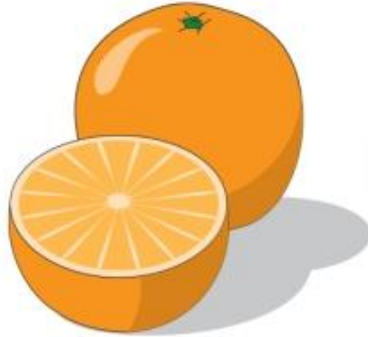

naranča

N

n

Nn

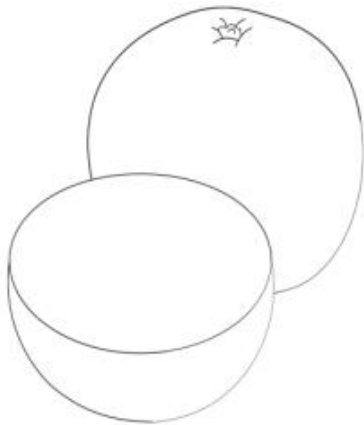

Nn

Nijnj

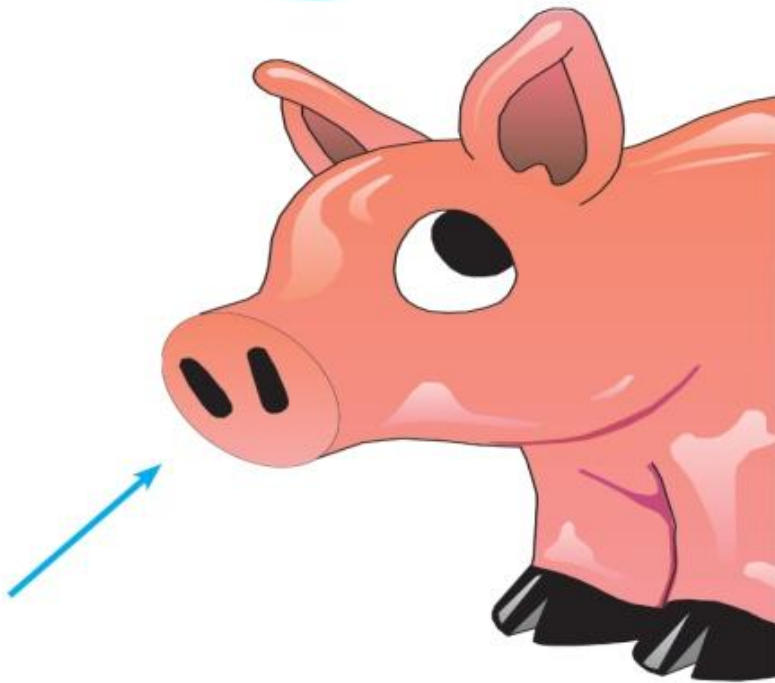

Njnj

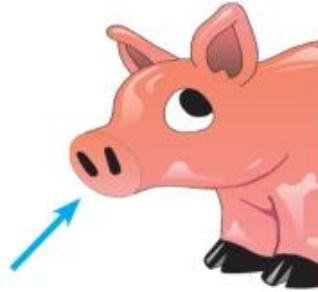

njuška

NJ

nj

Njnj

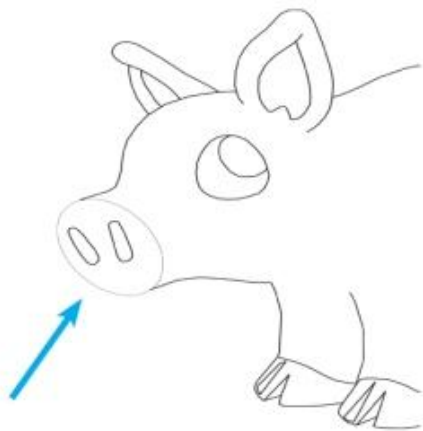

Njnj

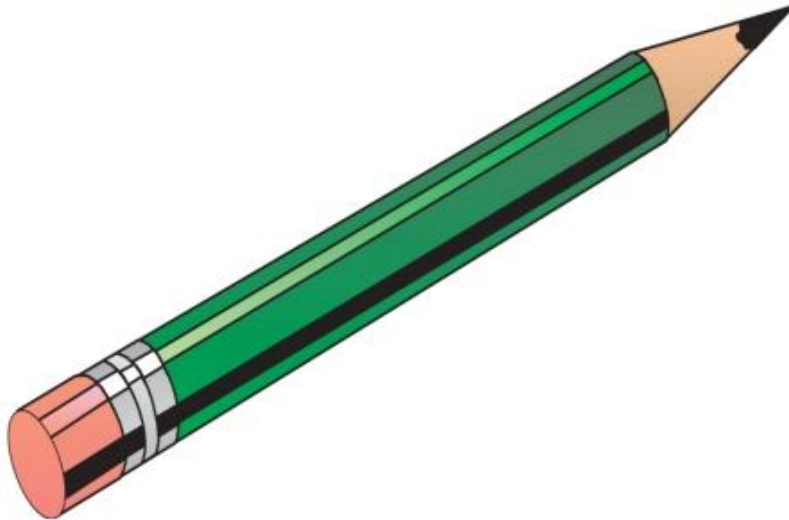
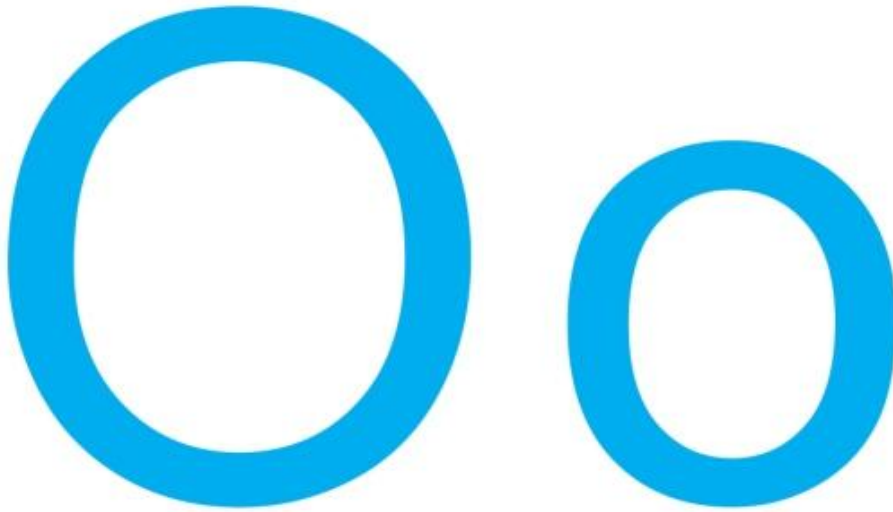

Oo



olovka

O

o

Oo

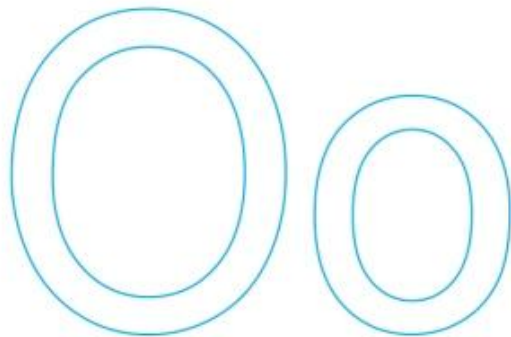
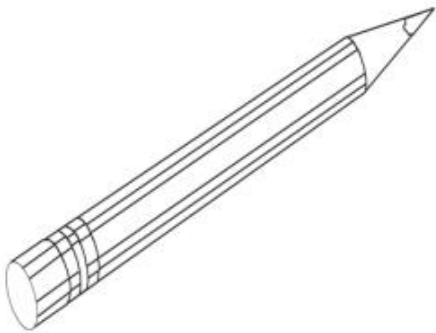

P p



Pp



prozor

P

p

Pp



Pp

Rr

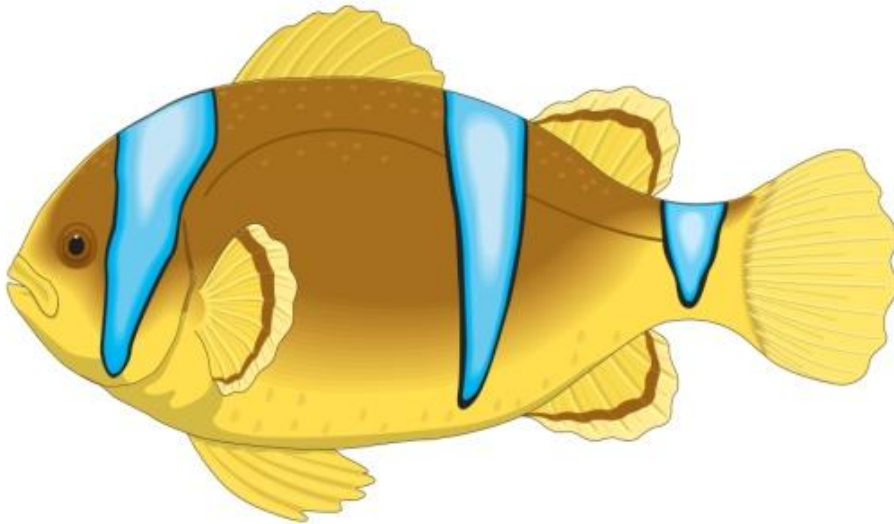

Rr



riba

R

r

Rr

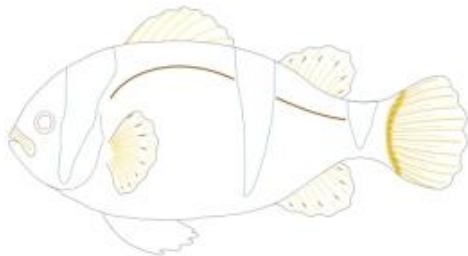

Rr

S s

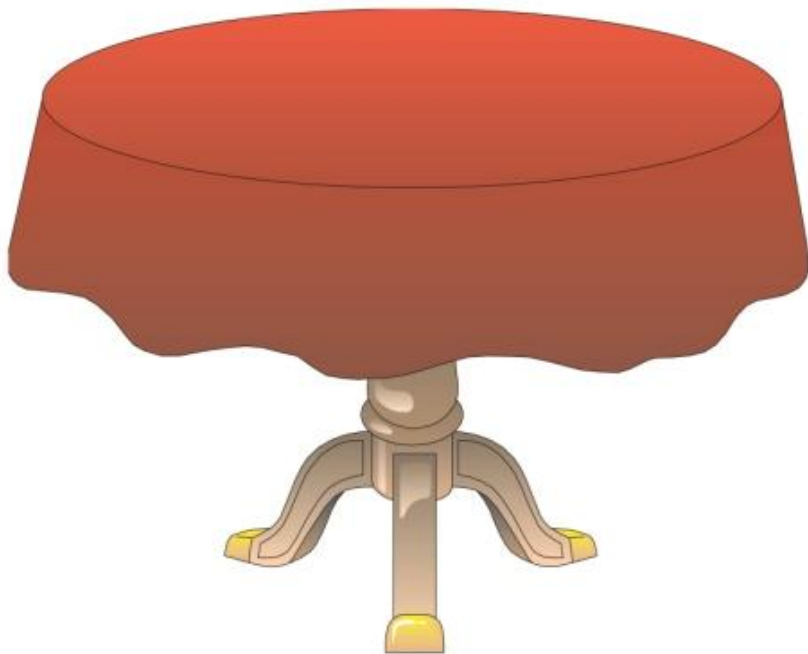

Ss



stol

S

s

Ss

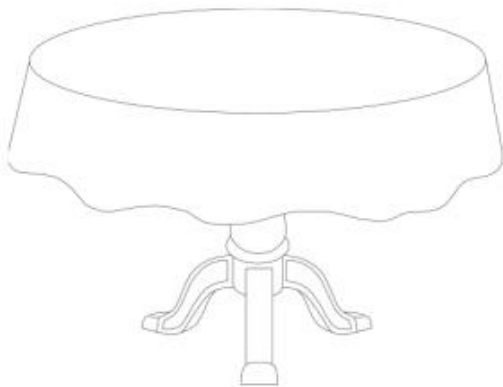

Ss

Š

š



Šš



špekula

Š

š

Šš



Š Š

T t



Tt



tobogan

T

t

Tt



Tt

U u

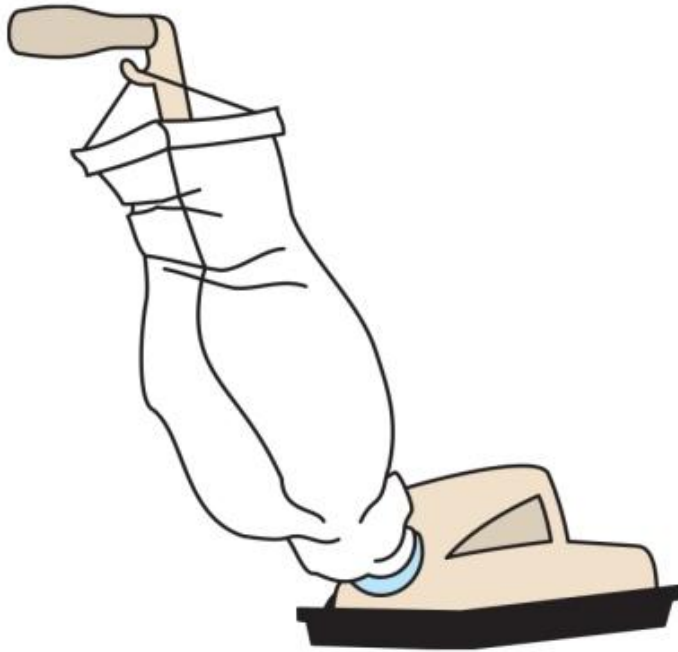

Uu

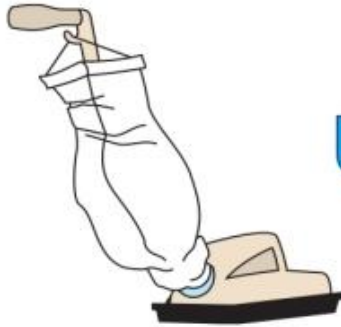

usisavač

U

u

Uu



Uu

V V



Vv



vatra

V

v

Vv

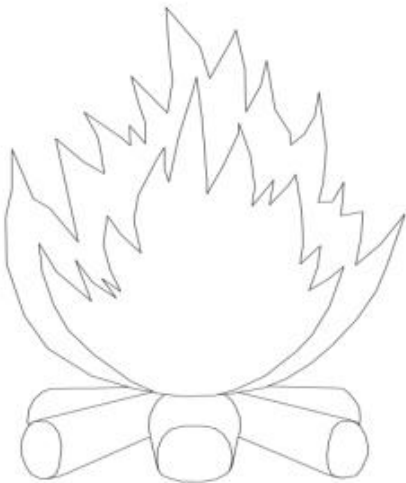

Z z

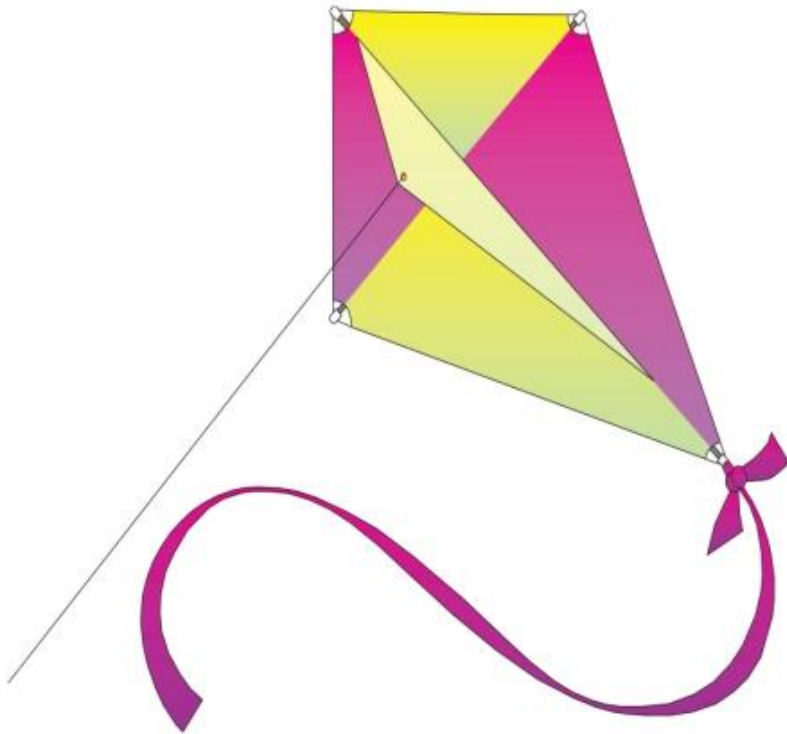

Zz

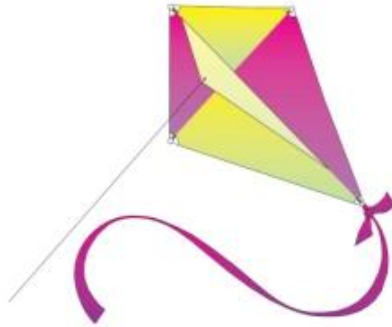

zmaj

Z

z

Zz

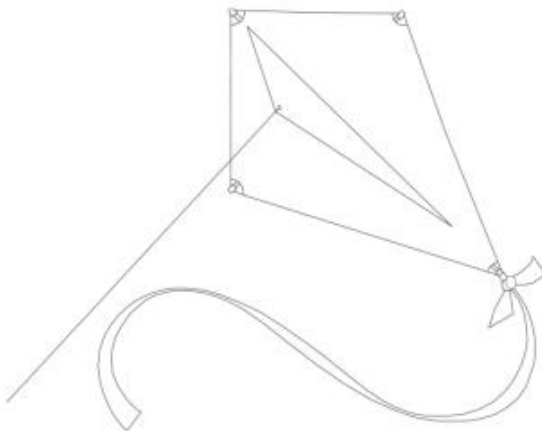

Zz

Ž ž

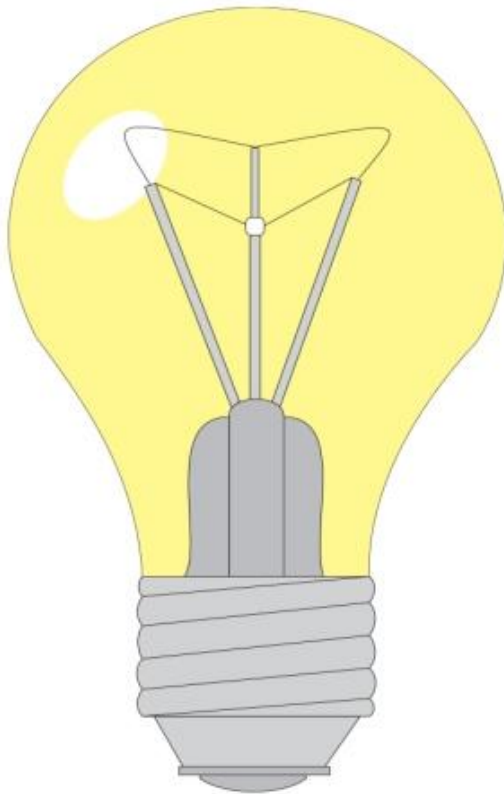

Žž



žarulja

Ž

ž

Žž



Žž